

FRONT VIEW

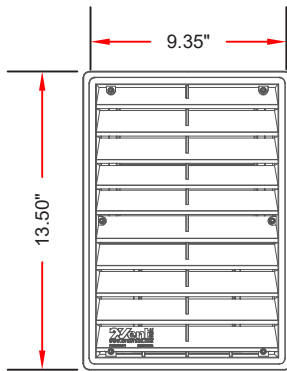

SIDE VIEW

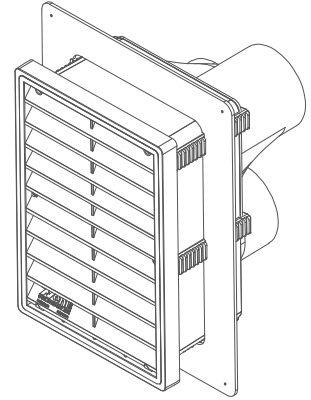
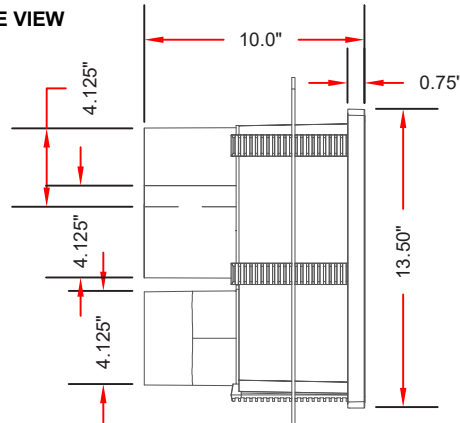

REAR VIEW

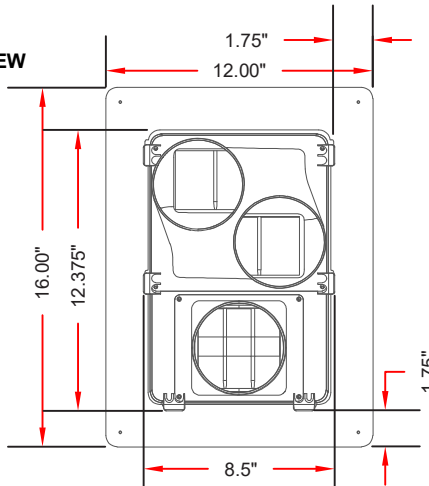

SECTIONAL VIEWS

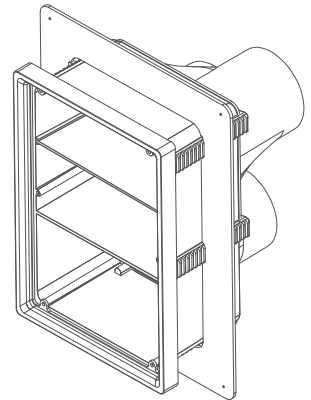
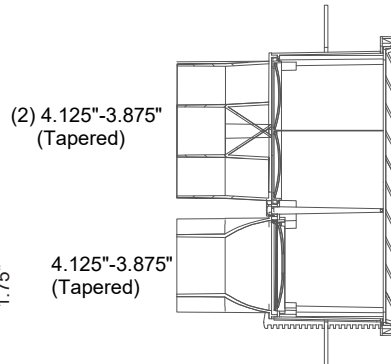

GENERAL INFORMATION

FOR USE

- Bathroom exhaust
- Dryer exhaust
- Kitchen hood exhaust
- Fresh air make-up
- Devices that require exterior exhaust or intake

MATERIALS

- Constructed from high temperature plastic polymers
- Material tested for use on high temperature appliance devices or components. (max sustainable operational temperature at 235°)
- ICC-ES PMG Product Certification, ASTM E-84 / UL-723, UL-94-VO
- All components made and fully assembled in the USA

BENEFITS

- Prevents exterior air from entering interior area
- Prevents mold & mildew*
- Eliminates water intrusion**
- Sold assembled
- Single step installation
- Greatly reduces labor cost
- Fits duct sizes up to (3) 4" diameter ducts
- 100% non corrosive material
- Box cavity designed not to interfere with structural design

FEATURES

- Adjustable mounting flange
- Interior monolithic cavity, positive pitch sidewalls
- Mounted flush with exterior building surface
- Paintable, primer required
- Gravity back draft dampers
- Removable front louver for periodic maintenance and inspections
- Face louver is attached with six stainless steel screws
- Impact resistant
- UV stabilized
- Available in White or Custom colors

* with proper interior environmental conditions

** in accordance with manufacturer recommendations, connected to a ducted system

NOTE: Product improvement is a continuing endeavor. Therefore, materials, appearance, and specifications are subject to change without notice.

Information provided herein is an estimate, and any specifications listed should be independently verified. Benefits described herein apply only to the extent that the product is installed properly, with the correct fit, and used for its intended purpose. This document does not constitute a promise or warranty by Red Viking Group Inc that all products will perform as stated herein. Red Viking Group Inc disclaims any implied warranty of merchantability. For product warranty, please see www.xventbox.com/warranty.